

Innovation in Motion

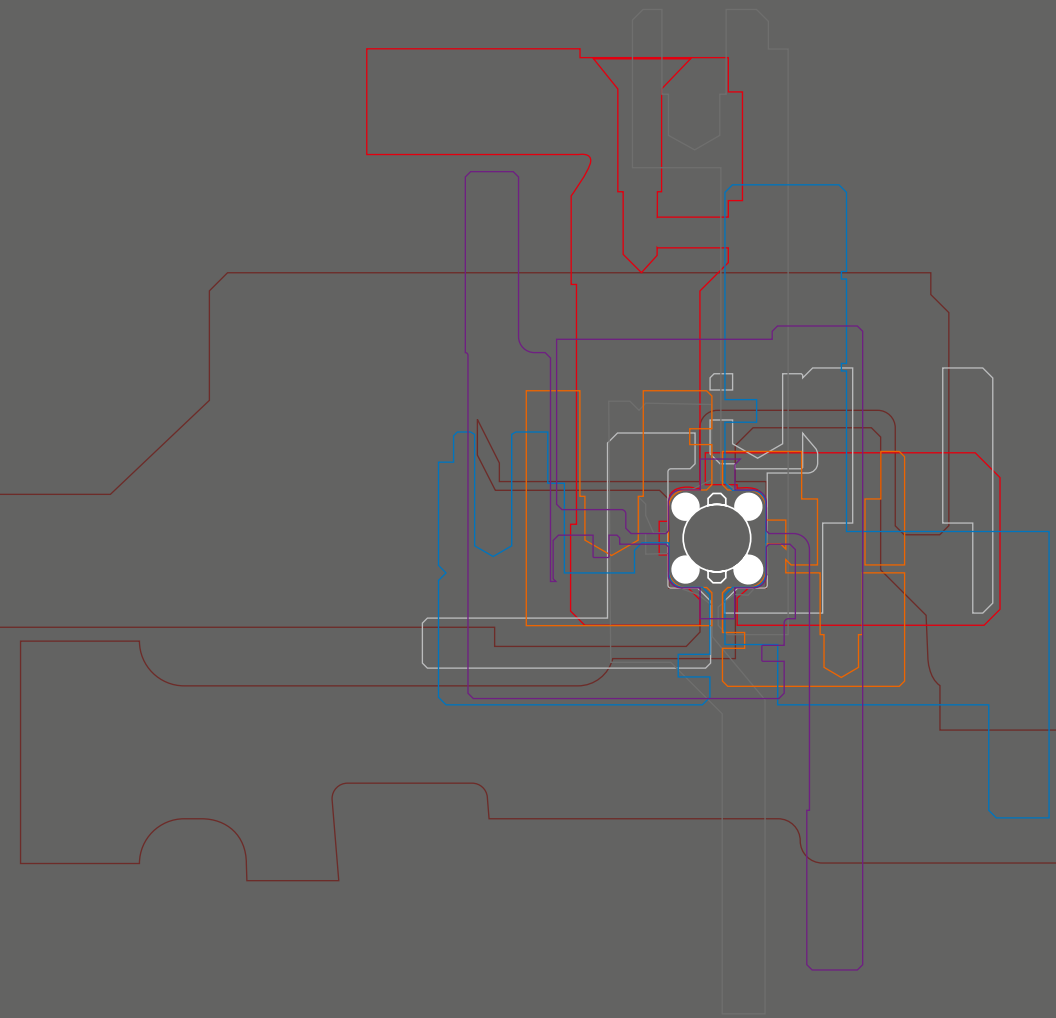

This is Franke.

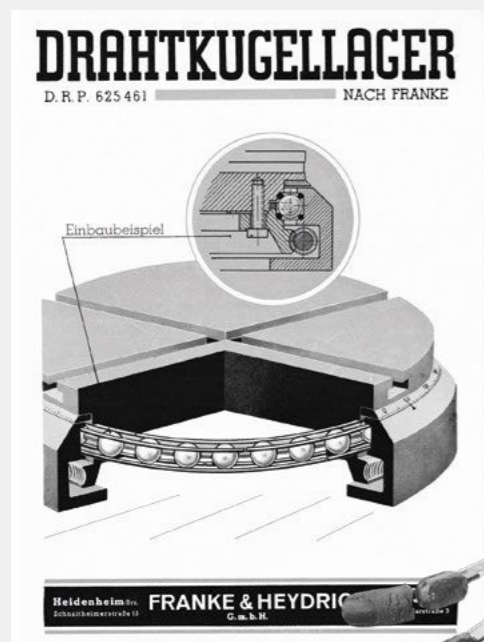

The Consideration

Crucial for the function and performance of a rolling bearing are raceways which are precisely adapted to the rolling elements.

Our Invention

We insert race rings of hardened wire in an enclosing structure. This concept ensures maximum functionality of the bearing - regardless of the material and geometry of the housing parts.

Your Benefit

Due to this design principle wire race bearings require only little space. Material and shape of the enclosing structure are completely unlimited. Thus saving weight and minimizing drive power.

The Times are changing – the Principle remains.

The first brochure about Wire Race Bearings from the year 1949 and Wire Race Bearings as an innovation impulse for modern handling robots.



point-contact principle to take equal loads from all directions.

28

representations worldwide offer their services close to our customers.

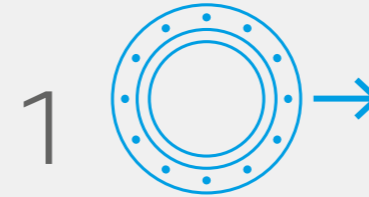

1 new prototype of a customized special bearing leaves the factory on average per week.

95%

of our products are bespoke versions of our bearings and linear systems.

280

employees take care of the needs of our customers at our headquarters in Aalen, Germany.



1 to 12 mm

are the diameters of our hardened steel wires used as raceways.



40 to 2,000 mm

is the diameter range of wire race bearings we produce.

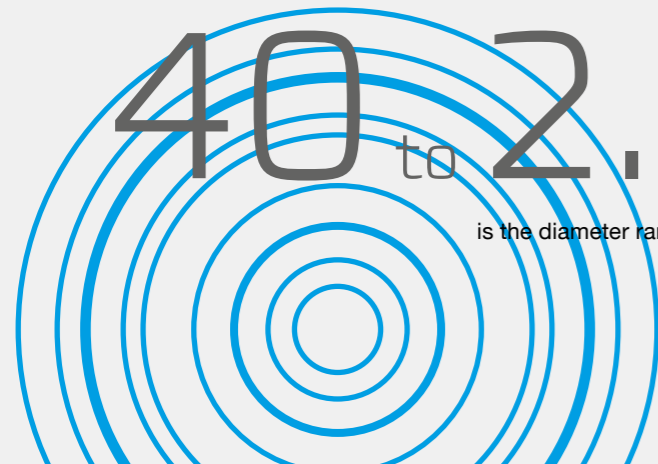

110,000

bearings of different kinds and sizes and

40,000 m

of linear guides leave the company per year.

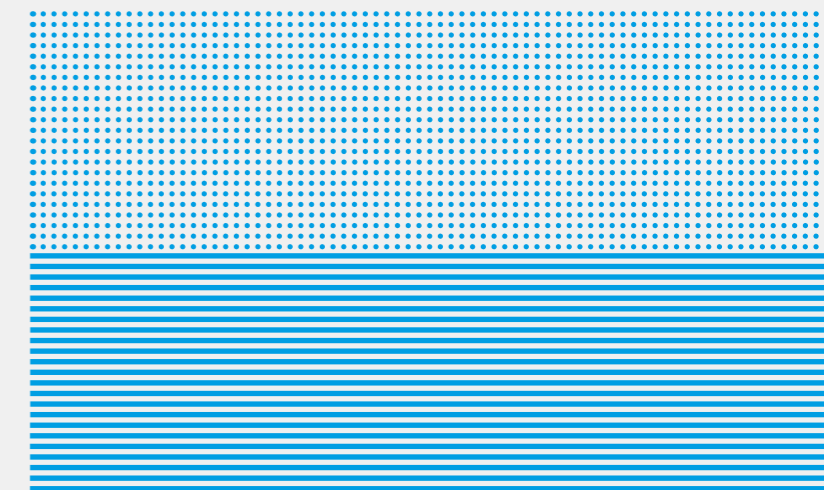



Innovation in Motion

Franke is the inventor of the Wire Race Bearing and the world leader in the development and manufacturing of lightweight movement systems. Our product range includes rotary and linear components with and without drive.

Our core competence is the development of innovative solutions together with our customers. The great versatility of Wire Race Bearings always leads to an optimal solution for the respective application.

Our motivation is to establish the Franke principle in ever new fields of application. The highest standards of technology, quality and customer service are always the focus. This makes our products fit for future challenges and inspires our customers.

We are representing the many excellent employees at Franke, the high quality standards of our products and services, as well as our brand values. This is Franke.

					
Sascha Eberhard General Manager	Oliver Schröder Procurement	Harald Müller Production	Stephan Kuhn Technical Sales	Jörg Egelhaaf Engineering and R&D	Daniel Gvoz General Partner, General Manager

Overcome the Limits

This high-tech 3D-laser-printed aluminum wire race bearing has a diameter of 300 mm and weighs 0.8 kg - 14 times less than a comparable steel bearing.



Completely customizable

For example, you can obtain wire race bearings with these properties:



corrosion resistant



food-compatible



highly dynamic



lubricant-free



lightweight



extremely cold and
heat resistant



Bearing Elements

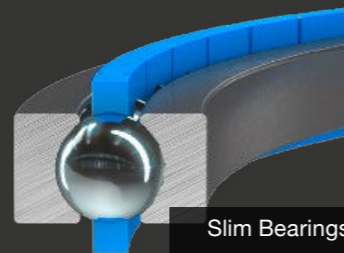

Slim Bearings

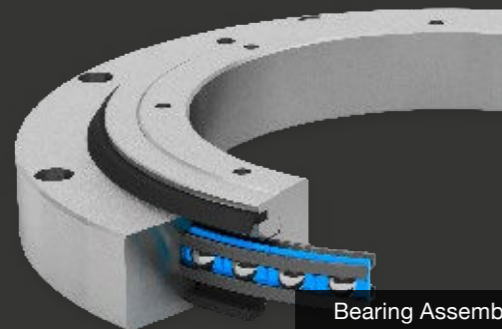

Bearing Assemblies



Rotary Tables

Wire Race Bearings

Franke Wire Race Bearings are compact, lightweight and strong. They are equipped with our 4-point-contact system and ground raceways. Available with diameters from 40 to 2,000 mm, as bearing elements, slim bearings, bearing assemblies, motorized rotary tables and integrated direct drives.

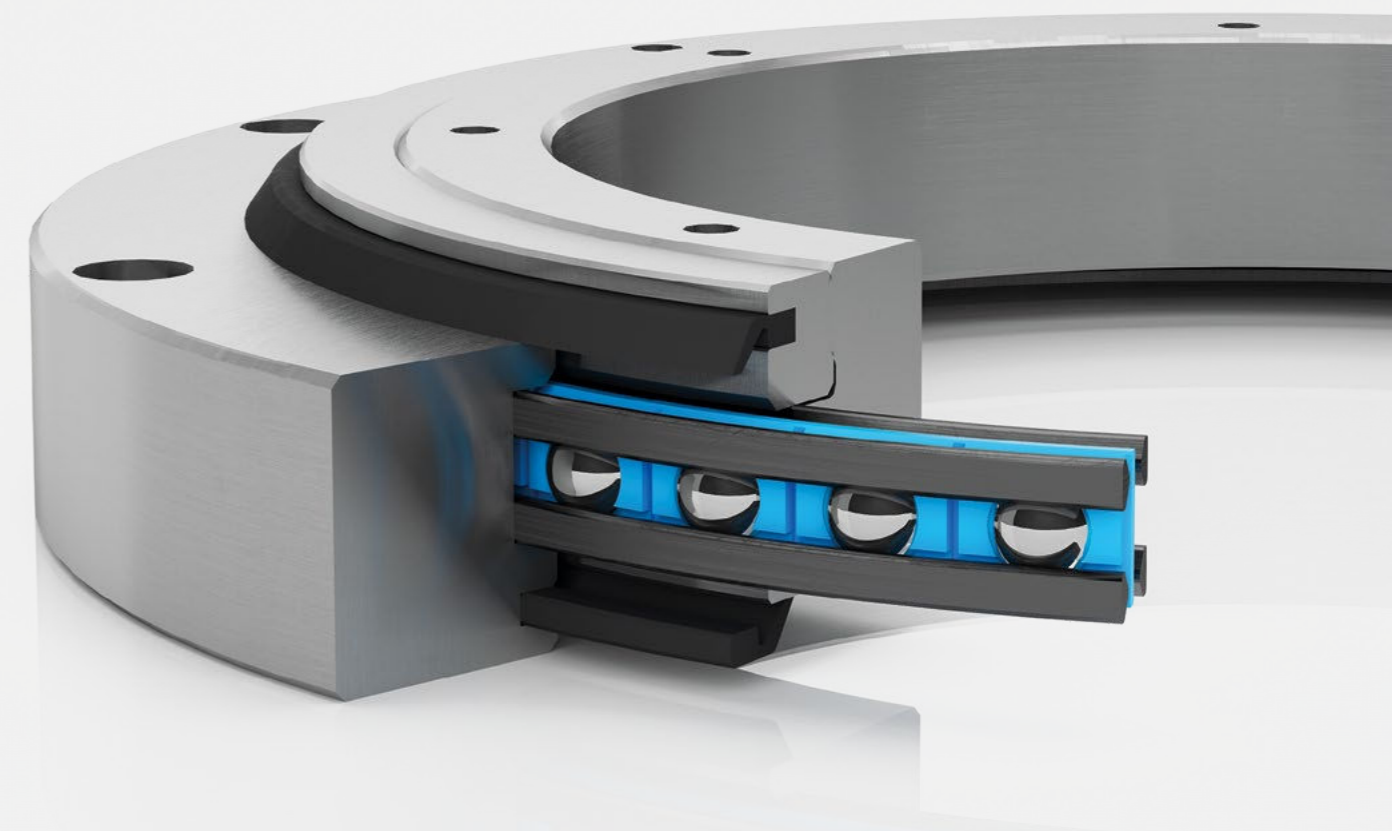

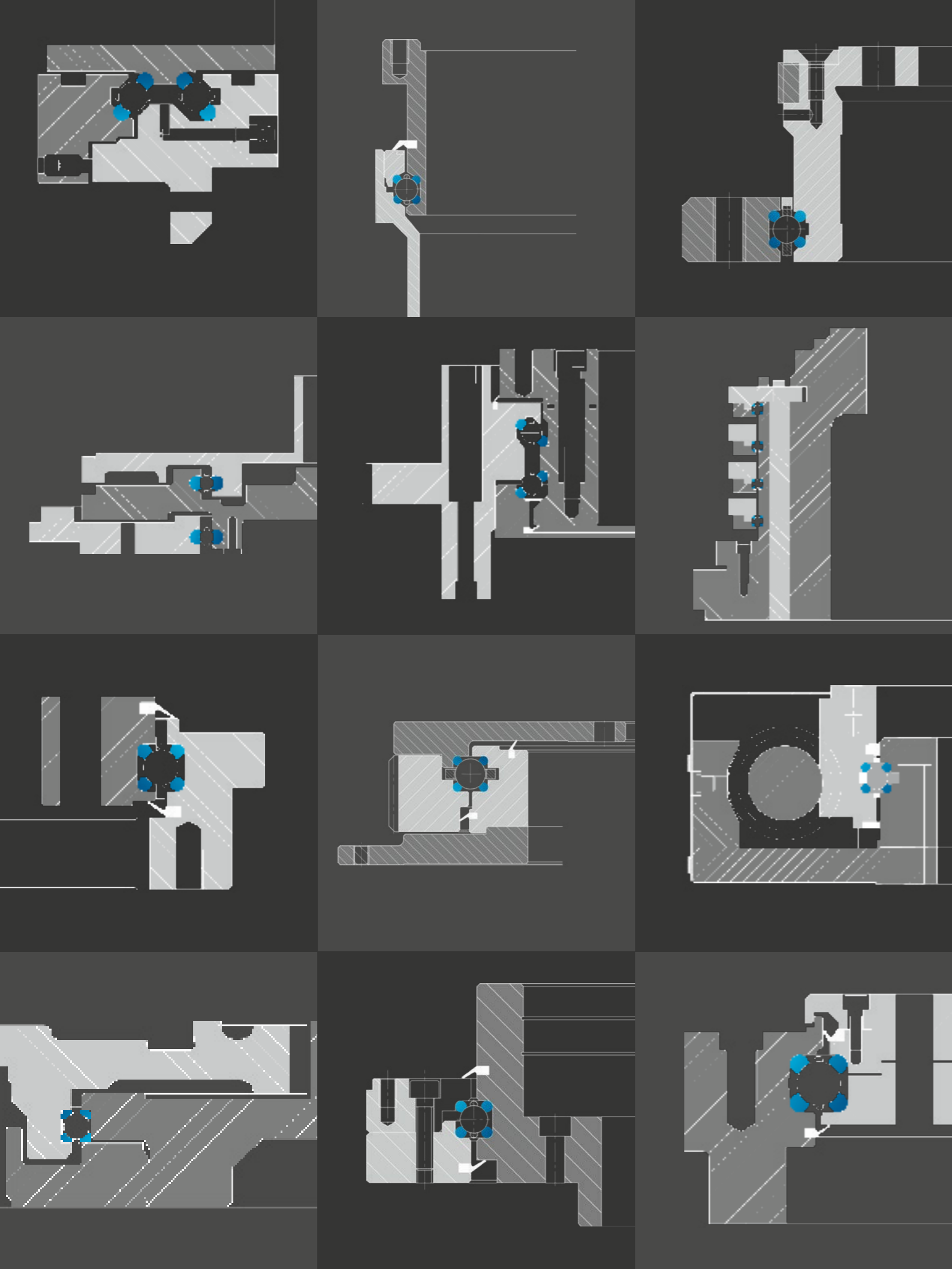

Infinite Possibilities

Franke Wire Race Bearings are space-saving, variable and individually adaptable. Together with our customers we develop the optimal solution for every application.

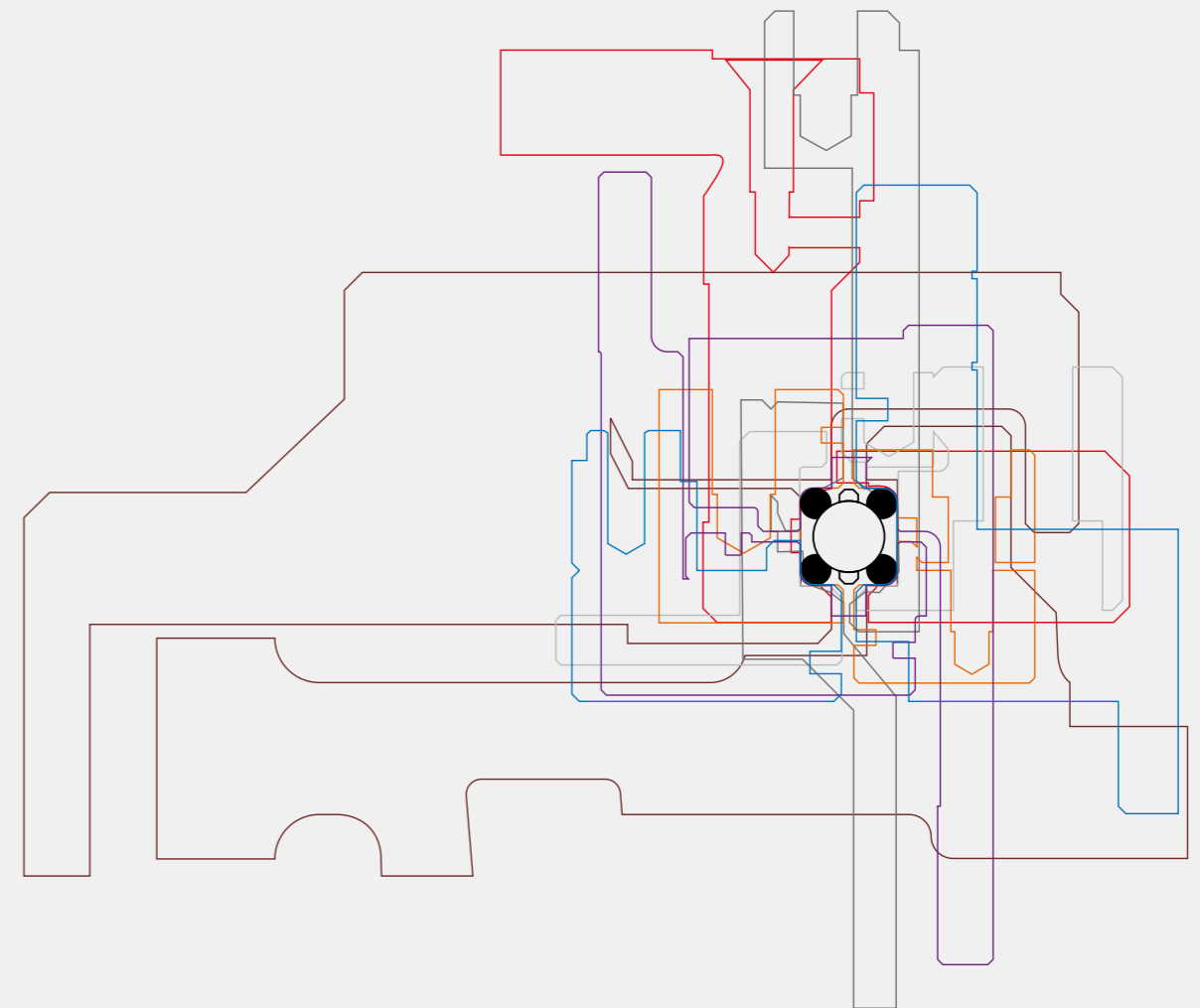



Automotive



Satellite Antennas

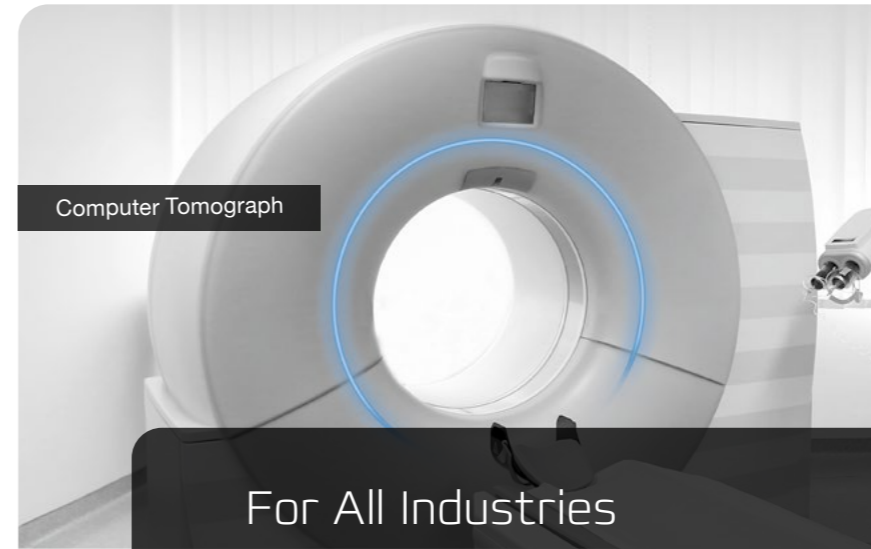

Computer Tomograph

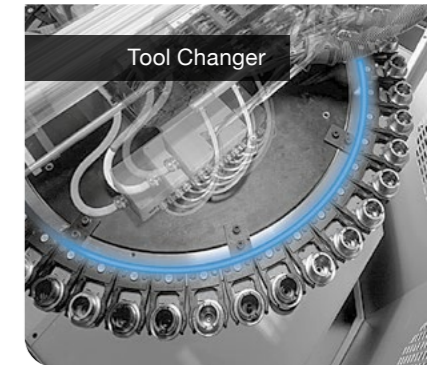

Tool Changer

For All Industries

Franke Wire Race Bearings offer substantial design freedom and free selection of material. The minimal mounting space is ideal for innovative design.



Aerial Camera



Filling Station

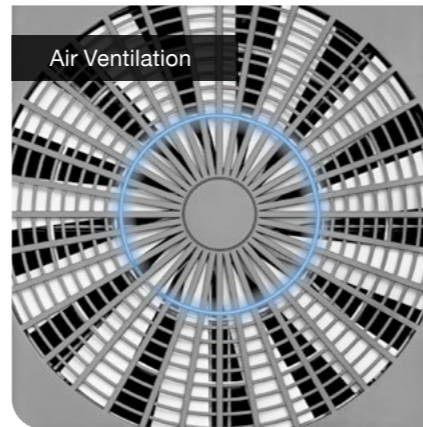

Air Ventilation



Air Craft Sensors



C-Bow X-Ray Unit



Direct Drive

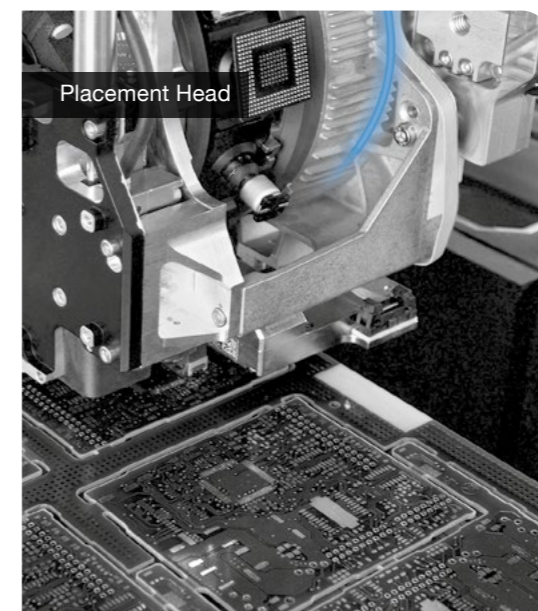

Placement Head



E-Mobility

Completely customizable

For example, you can obtain linear systems with these properties:



amagnetic



food-compatible



highly dynamic



lubricant-free



suitable for
cleanrooms



anodized in
color



Double Rail with Cassette

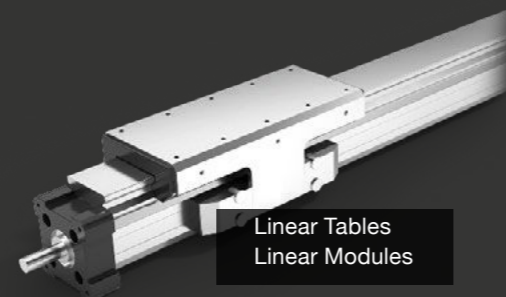

Linear Tables
Linear Modules

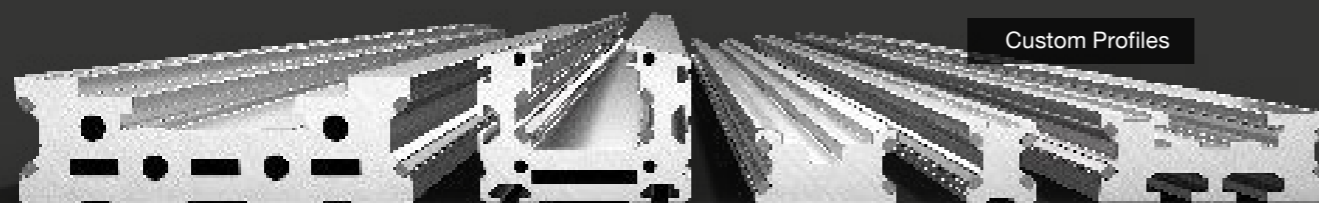

Custom Profiles

Linear Systems

Franke Aluminum Linear Systems with aluminum body, steel raceways and crosswise arranged rollers for loads from all directions. v_{max} 10 m/s, acceleration 100 m/s², with and without drive.





Dental X-Ray Unit



Pick & Place

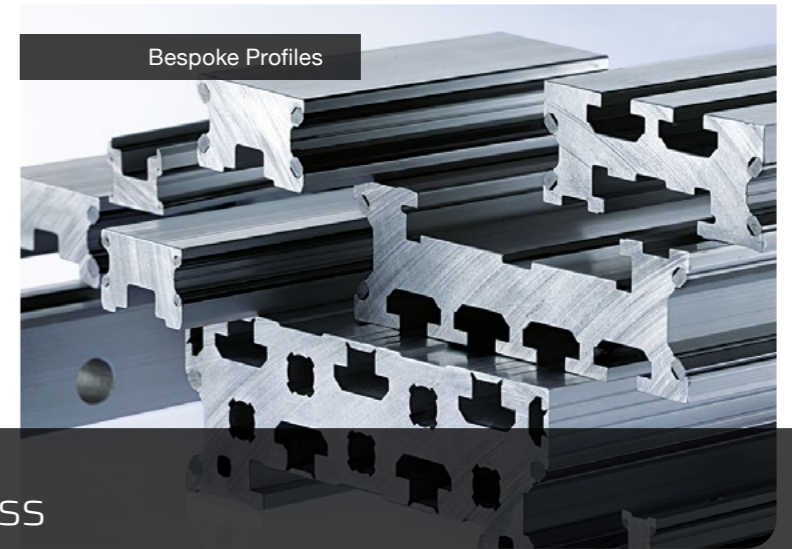

Bespoke Profiles

Linear Lightness

Franke Aluminum Linear Systems with and without drive are light and silent, highly dynamic and maintenance-free. With serial production, they are also available with individual rail profiles and cassette design.



Packaging



Food Production



Bespoke Cassette



Camera Slider



Water Cutting



Packaging

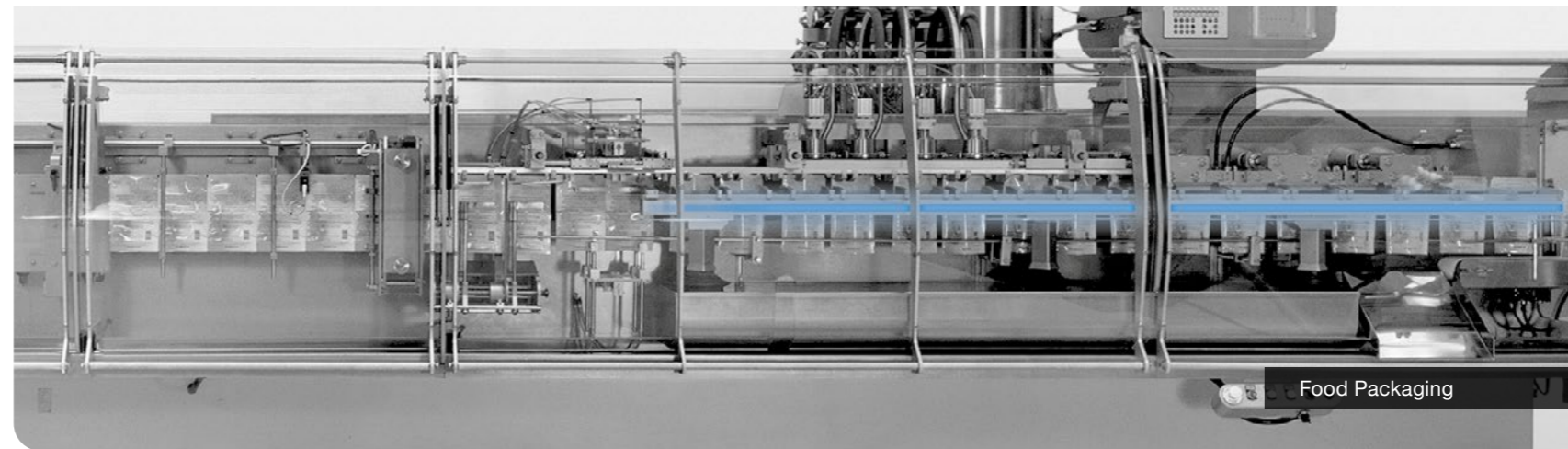

Food Packaging



Franke Worldwide

Franke Wire Race Bearings and Linear Systems are available worldwide. Representatives and partners in numerous countries support our customers with advice and service offers. Cooperations with strong partners in North America and Asia enable on-site production and help us deliver to our customers quickly and cost-effectively.

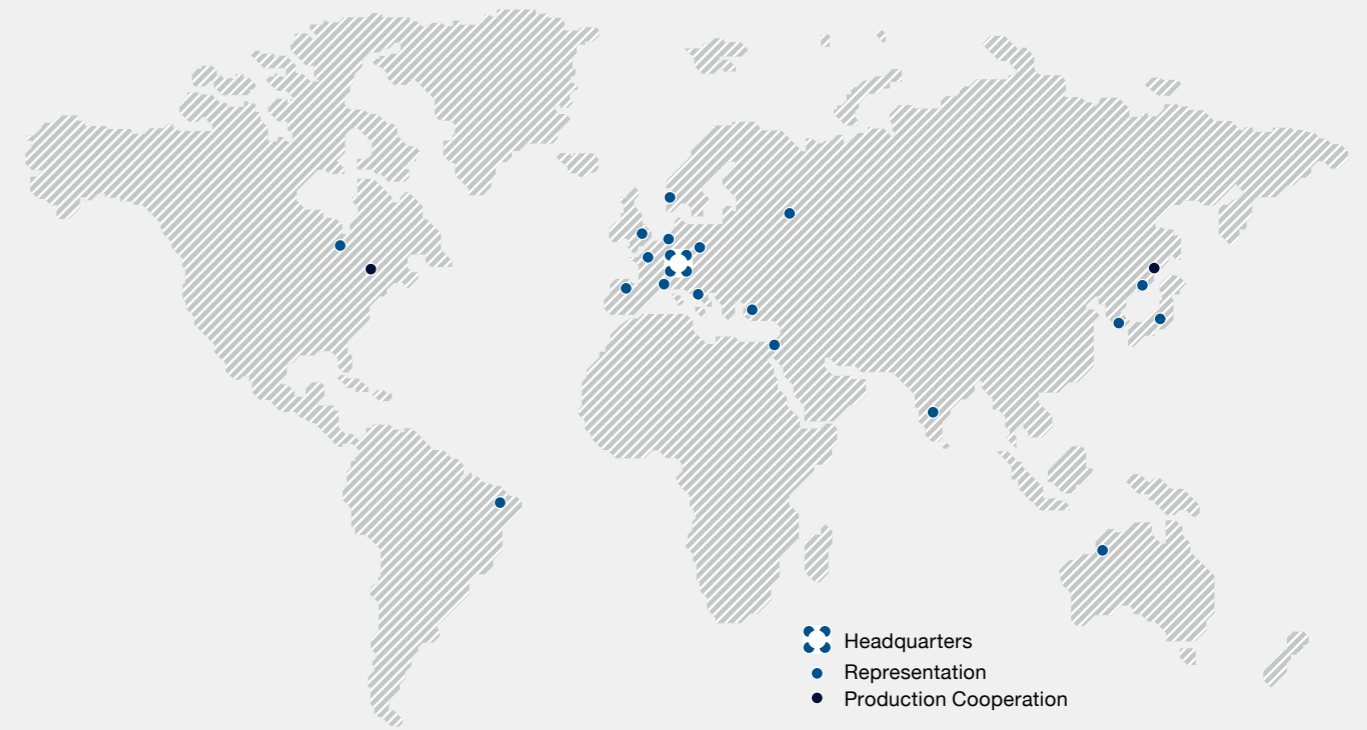

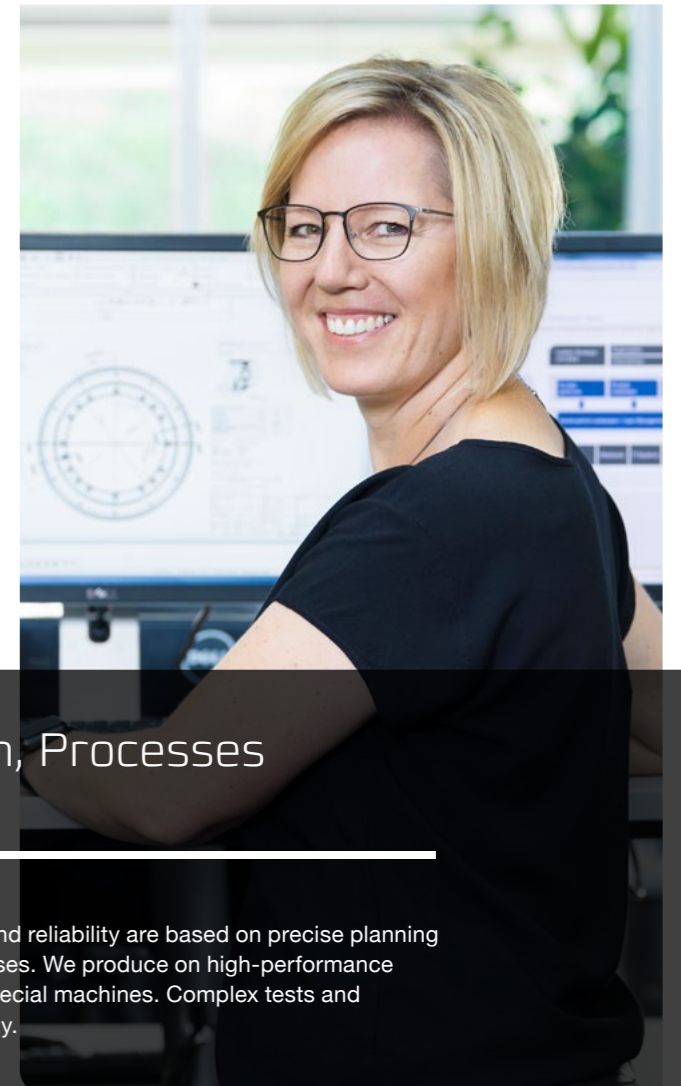
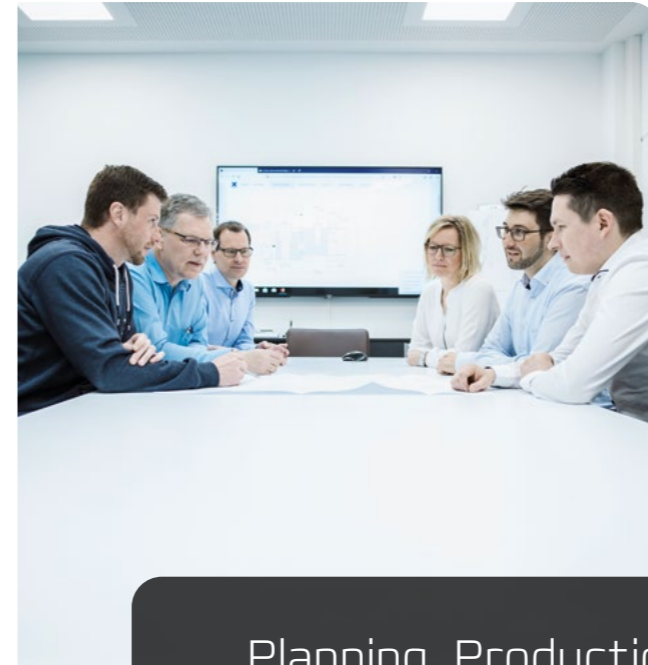
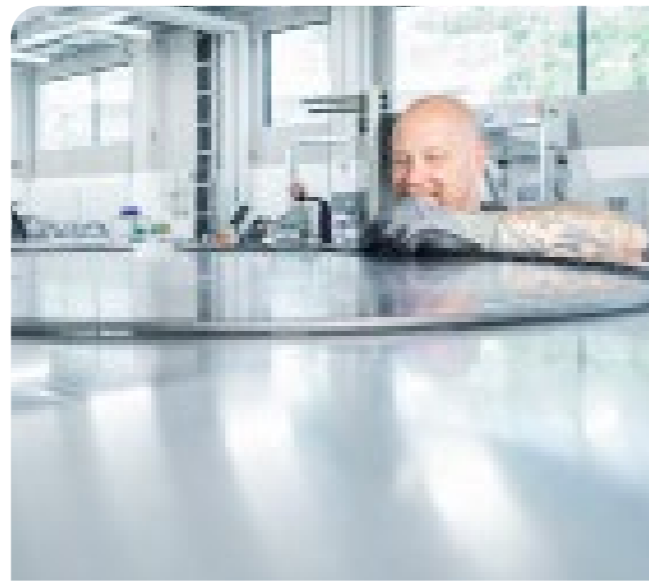

Planning, Production, Processes

Our quality features precision, longevity and reliability are based on precise planning as well as on harmonized and fast processes. We produce on high-performance machining centers and Franke-specific special machines. Complex tests and precision measurements ensure top quality.





www.franke-gmbh.com



Franke GmbH
Obere Bahnstraße 64
73431 Aalen, Germany
Tel. +49 7361 920-0
Fax +49 7361 920-120
info@franke-gmbh.de